

PRODUCT SPECIFICATION



Part No. : JH-12RGBW14G45-R9C
High Power LED

Catalog

1.Product Features	P2
2.Dimensions	P2
3.Absolute Maximum Rating	P3
4.Optical Character	P3
5.Optical Character Curves	P4
6.Spectrum Curves	P5
7.Viewing Angle Curves	P5
8.Cautions	P6

1.Product Features

- High Brightness RGBW LED
- Plane Package
- Viewing Angle 140 Degree
- Chip Material: InGaN AlGaInP
- RoHS Compliant

2.Dimensions

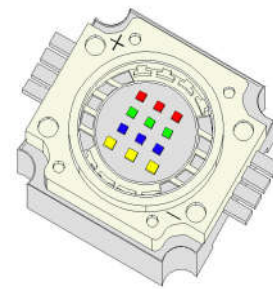
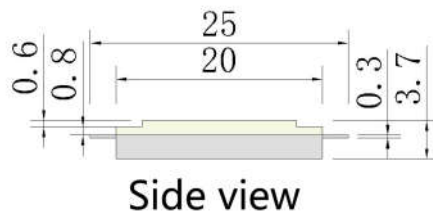
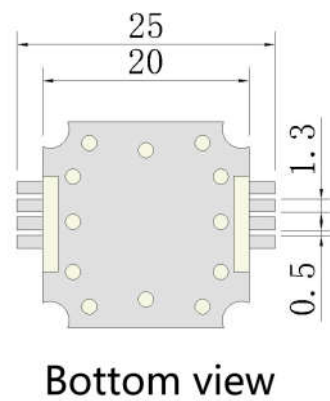
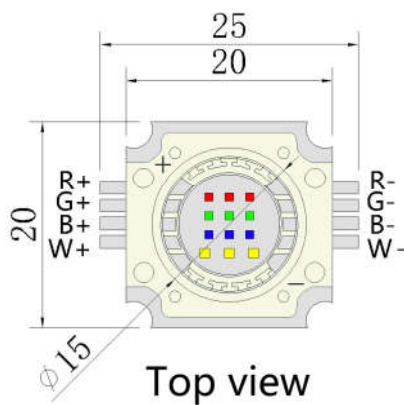

Perspective view

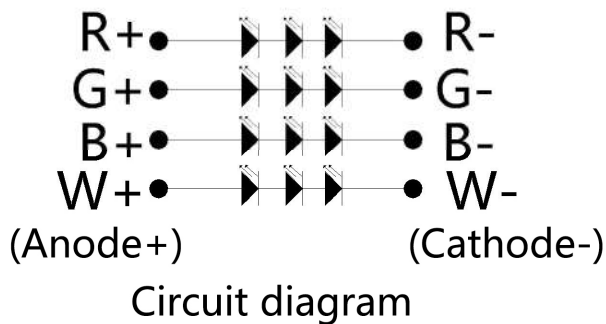

Notes:

1. All dimensions are in millimeters.
2. Tolerance is $\pm 0.1\text{mm}$ unless otherwise noted.

3. Absolute Maximum Rating @ Ta=25° C

Parameter	Symbol	Maximum Rating	Unit
Continuous Forward Current	IF	350	mA
Peak Forward Current (1/10 Duty Cycle, 0.1ms Pulse Width)	IFp	500	mA
Reverse Voltage	VR	5	V
Power Dissipation	PD	12	W
Electrostatic Discharge	ESD	1000	V
Operating Temperature Range	TOPR	-25°C to +80°C	
Storage Temperature Range	TSTG	-35°C to +100°C	
Lead Soldering Temperature	TSOL	260°C	

4. Optical Character @ Ta=25° C

Parameter	Symbol	Color	Min.	Typ.	Max.	Unit	Test Condition
Forward Voltage	VF	R	6	6.5	7	V	IF=350mA
		G	9	9.5	10	V	IF=350mA
		B/ W	9	9.5	10	V	IF=350mA
Luminous Flux	Φ	R	150	165	180	Lm	IF=350mA
		G	240	255	270	Lm	IF=350mA
		B/ W	75/300	90/330	105/360	Lm	IF=350mA
Dominant Wavelength	Wld	R	620	622.5	625	nm	IF=350mA
		G	520	522.5	525	nm	IF=350mA
		B	460	462.5	465	nm	IF=350mA
Colour temperature	Tc	W	6000	6500	7000	K	IF=350mA
Reverse Current	IR				10	μA	VR=5V
Viewing Angle	2θ1/2				140	deg	IF=350mA
Recommend Forward Current	IF(rec)	RGBW			350	mA	

Notes:

Measurement tolerance of forward voltage ±0.1V

5. Optical Character Curves

(25 ° Ambient Temperature Unless Otherwise Noted)

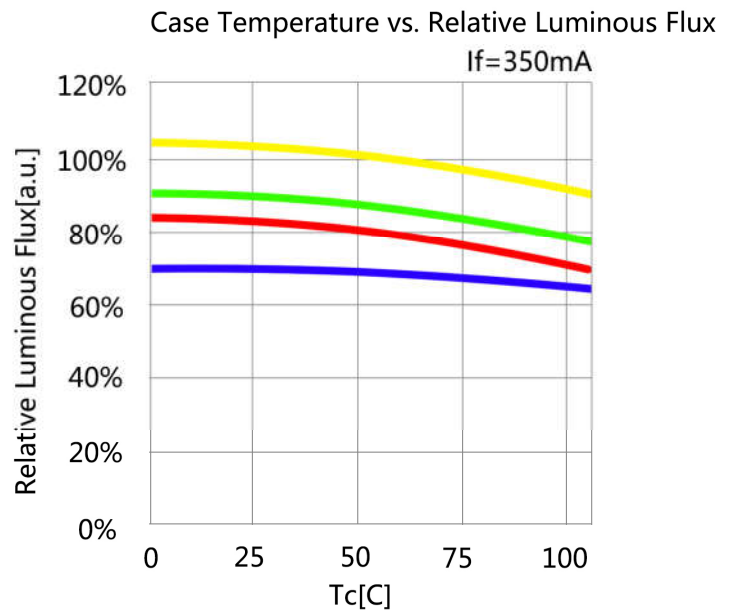
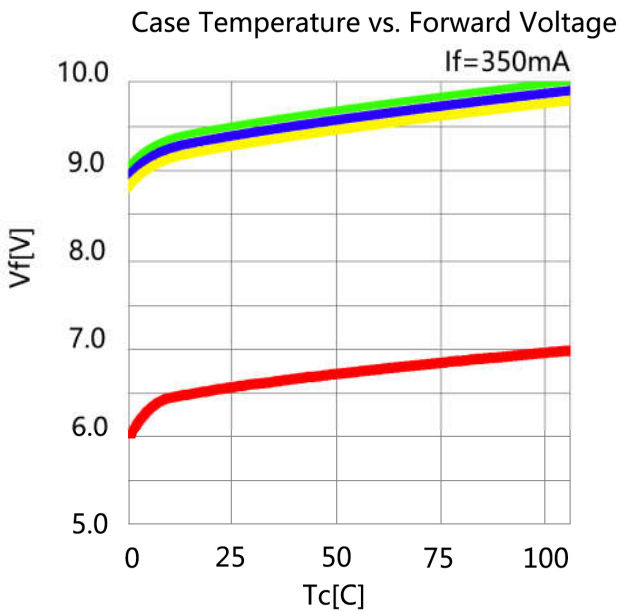
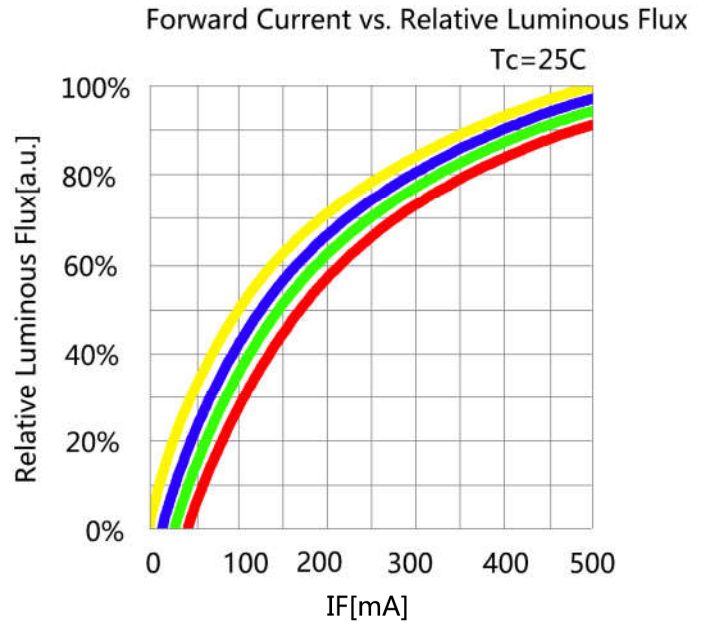
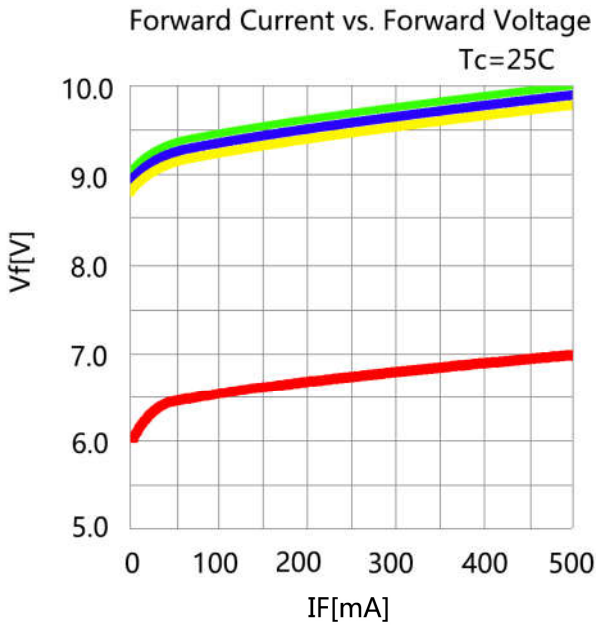

6. Spectrum Curves

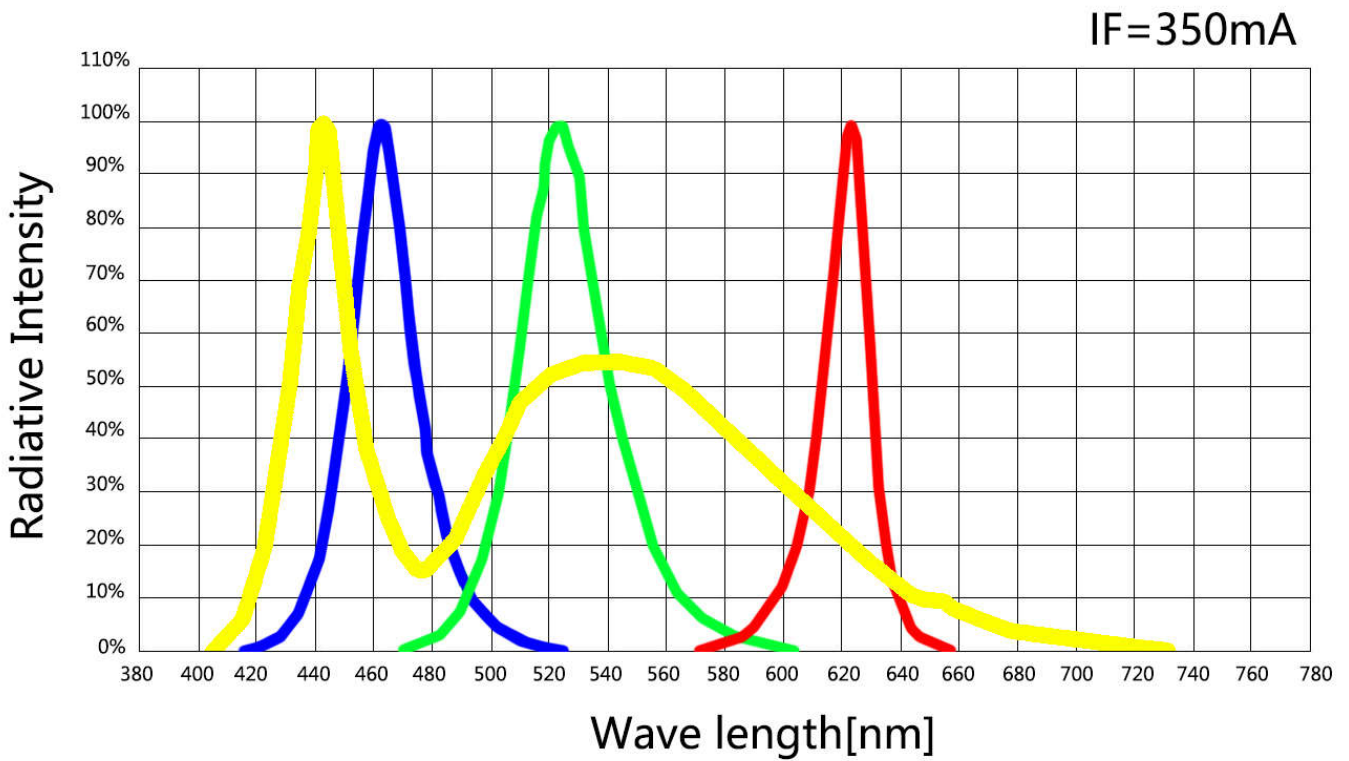

7. Viewing Angle Curves

Radiation Characteristic

IF=350mA

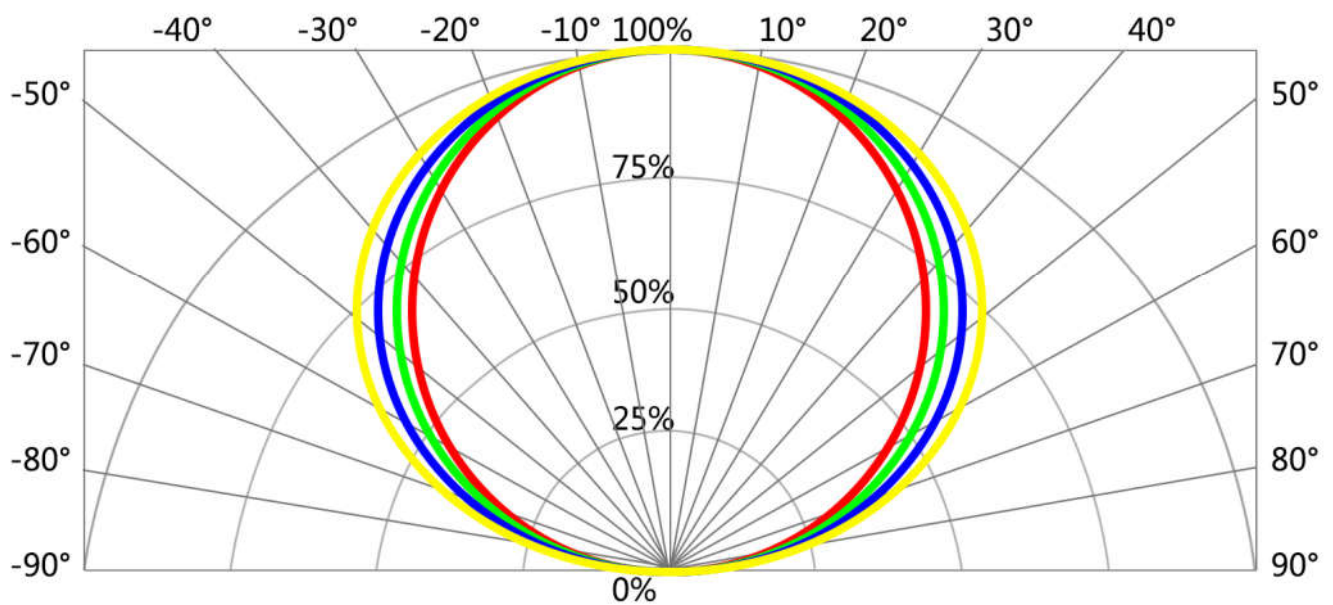

8.Cautions

1. Electrostatic Treatment

Do a full range of anti-static measures (such as: anti-static ring, anti-static clothes, machine, equipment grounding wire, etc.)



2. Heat Dissipation

A、 It is recommend to configure reasonable heat dissipation device for the product.

B、 The best working temperature range of the product is 40-60°. It is recommended to control the working temperature of the product within a reasonable range.

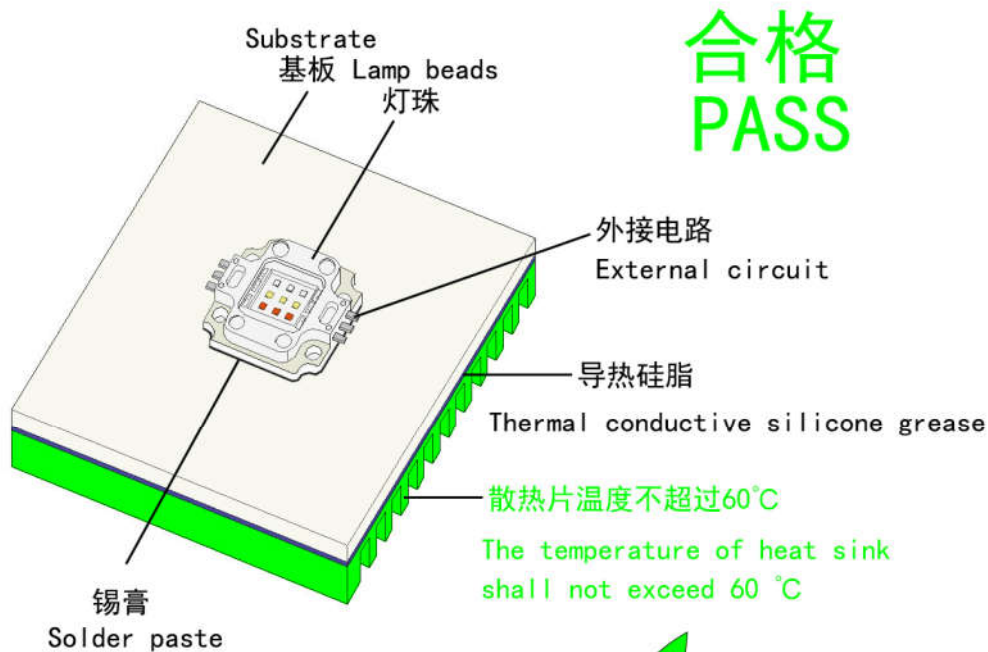

合格
PASS

OK

